



## PRESTRESSED COMPOSITE BOX GIRDER BRIDGES

Prof. Ing. Giuseppe Mancini-Politecnico di Torino

**ABSTRACT:** *Can a massive highway viaduct match the gentle principles of environment friendly and sustainable architecture? In the present work will be illustrated how a traditional structure can be re-invented in order to fulfil the rules of environmental design. The outcome of such approach will turn out to be not only ecological but also less expensive and quicker to be built than traditional structures. If we add that this sustainable bridge is not only a mere theoretical case-study, but it is already built and has the world span record for its category, we can truthfully state that a goal in life cycle design engineering has been probably achieved.*

**Keywords:** Durability, Sustainability, Bridge, Desi

## INTRODUCTION

For about twenty centuries constructions have been inspired to the Marcus Vitruvius Pollio, a Roman soldier, requirements: *Firmitas*, *Utilitas*, *Venustas*. Such requirements today may be translated as Robustness and Safety (*Firmitas*), Serviceability and Functionality (*Utilitas*), Elegance and Beauty (*Venustas*).

On the other hand, it has to be recognised that during the past two decades those requirements have been integrated in a more general concept, generally named “Sustainability”. According to the Brundtland Report [1], sustainable development is defined as “the development that meets the needs of the present without compromising the ability of future generations to meet their own needs”.

It can be appreciated that the construction process has recently been substantially influenced by sustainability concept, as envisaged in *fib* Bulletin 28 [2], in which the transformation from the old traditional construction process to the new sustainable approach is clearly pointed out (figure 1). That figure clearly shows to which extension environmental issues, cultural and social aspects and economic constraints are able to influence the basic approach to construction process.

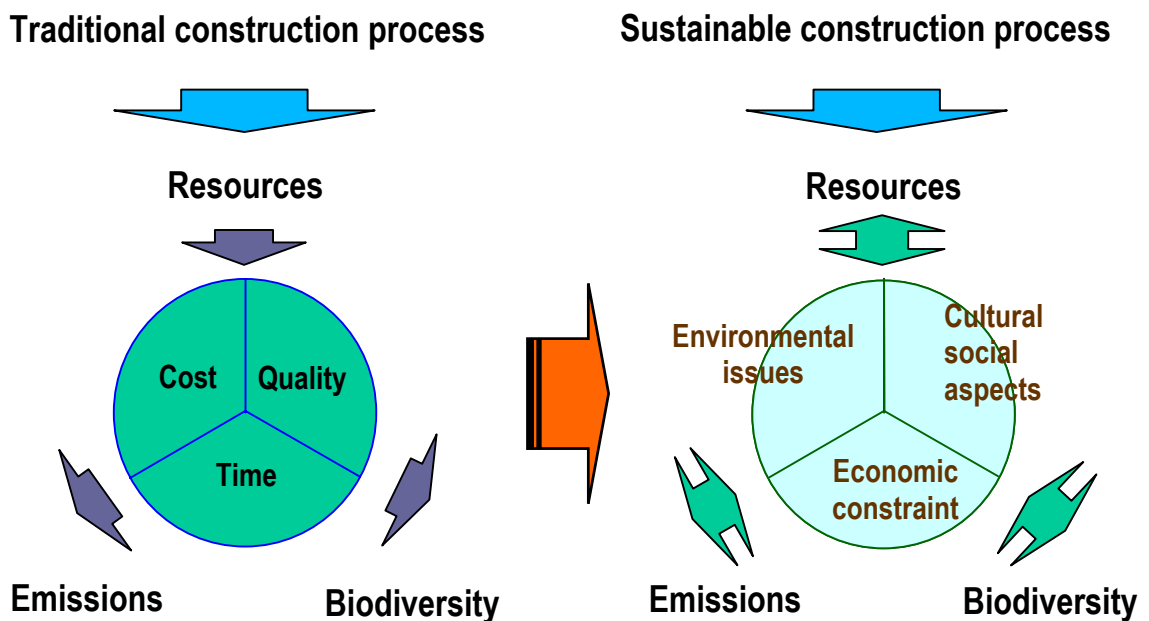

Figure 1 Transformation from traditional construction process to sustainable one.

The fulfilment of sustainability implies a complete life-cycle assessment (LCA), which takes into account the environmental aspects and potential impacts associated with the existence of a product within the whole life cycle, with the goal of minimizing the negative environmental impact.

Referring for instance to concrete structures, a full consideration of all the life phases of concrete product is required

- Raw material acquisition: mining of aggregates, mining of stones for cement production, energy sources and energy production, water supply;
- Realization: production of concrete and concrete elements, design, construction;
- Utilization: use, maintenance, repair, renovation;
- Service life end: demolition, re-use, recycling, disposal, landfill.

The potential chance to influence the degree of environmental impact ( $E_i$ ) throughout the whole life cycle of a concrete structure cannot be univocally defined, but a general international consensus has been reached on the qualitative subdivision pictured in *fib* Bulletin 28 (figure 2): as clearly shown by that figure, the main role on the reduction of environmental impact is played by:

- Conceptual design
- Technology concept
- Use/maintenance/repair
- Recycling

Finally, from the above considerations, it clearly appears that the sustainability approach requires a typical engineering method: learning from the past experience with the aim to avoid spending the resources, in the future, essentially in repairing the effect of the errors done in the past.

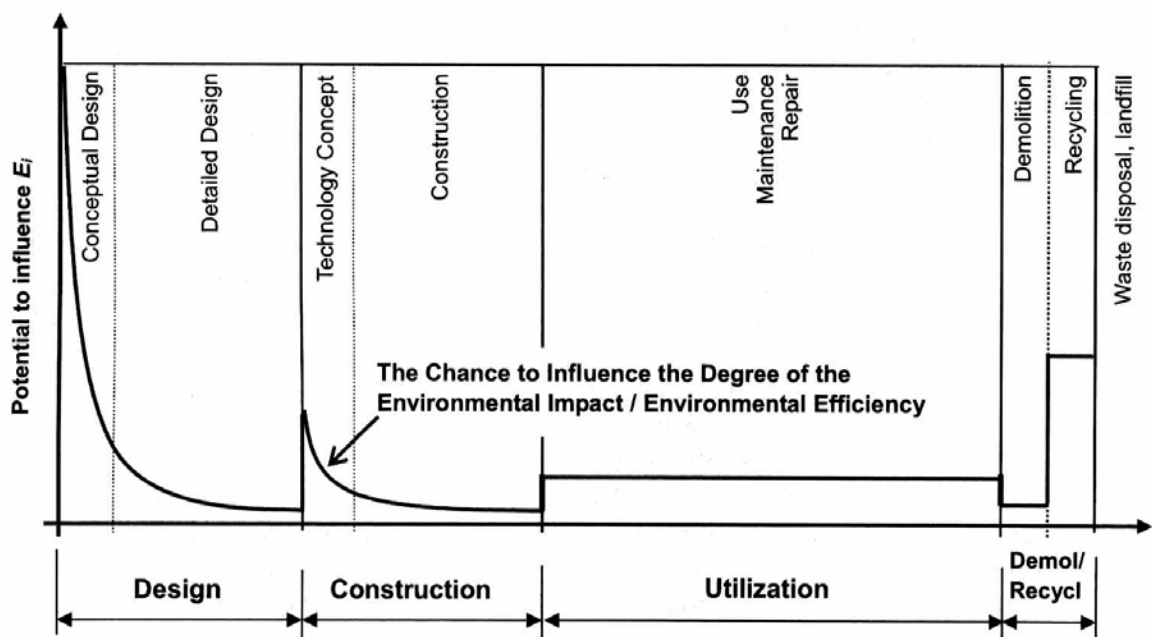

Figure 2 Life cycle phases of concrete structure (from *fib* Bulletin 28).

If now we focalize on bridges, we must recognise that durability aspects play a very important role. In fact, the present and the near future foresees for such structures:

- About 60% of investments in repair, strengthening and upgrading of existing infrastructures;
- About 40% of investments in construction of new bridges.

The errors made in the past should be avoided in both cases, analysing in detail the sustainability of any kind of intervention.

A recent construction in the bridge field will be presented in detail. It is essentially inspired to the sustainability and, in particular, to the durability, today conceived as a fundamental requirement that must, as far as possible, be satisfied. In particular, the future design should consider as main step the “design for durability”, in strict relation to structural service life, and then the verification of safety, serviceability and functionality.

## COMPOSITE BOX GIRDER BRIDGE

The construction technique of composite steel concrete bridges has recently received a new impulse by the use of external prestressing in the static scheme of continuous beam. This new conception of box-shaped deck bridge has turned out to be very interesting, because the use of steel is restricted only to the webs and both top and bottom slabs are realised in concrete. From a conceptual point of view, the compression stresses are essentially carried by concrete and the use of prestressing may lead to nil or very small tensile stresses in serviceability conditions (frequent combination). In addition, the extensive use of external prestressing enhances the durability and sustainability features of the bridge. In fact, it is possible to very easily inspect its conservation in time, and to substitute, without substantial limitation to operability, the tendons that eventually showed some kind of damage during the service life.

France, Germany and Japan can number several bridges of this kind, generally conceived using corrugated webs, to avoid stiffeners for the steel plates and to reduce the amount of prestressing that may migrate from concrete to steel.

The first application of such typology of deck in Italy is the Roccaprebalza Viaduct located along the Parma-La Spezia highway, which established the world record for the entity of typical span (120m) in the field of composite continuous beams with stiffened plated webs.

The viaduct has a total length of 624m realised with a counterweight (30m), four spans of 120m, one span of 71.4m and a final isostatic span of 42.6m. The reason for this last isostatic beam is the expectation of a landslide of some millimetres per year in correspondence of the last pier. The deck continuity has then been interrupted, and multi-directional bearings have been used on such pier, integrated by adjustable transversal restraint under continuous monitoring.

Figure 3 pictures the planimetric shape of the viaduct, whereas figure 4 shows the transverse sections of the deck on the piers and at mid-span. It can be easily seen that the planimetric layout is very complex due to the presence of a minimum radius of curvature of only 400m. The piers have also a high variation in depth, from a minimum of 13.15m (P5) to a maximum of 82.07m (P2).

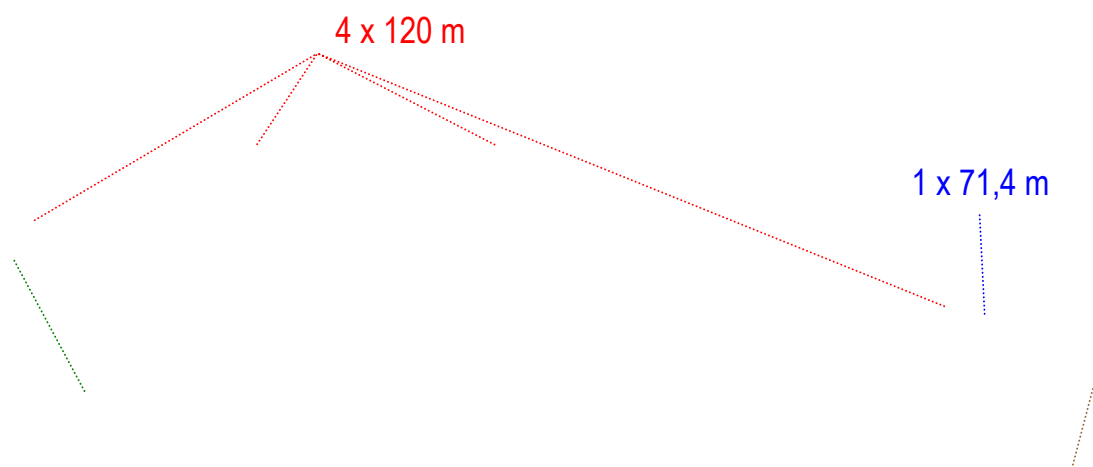

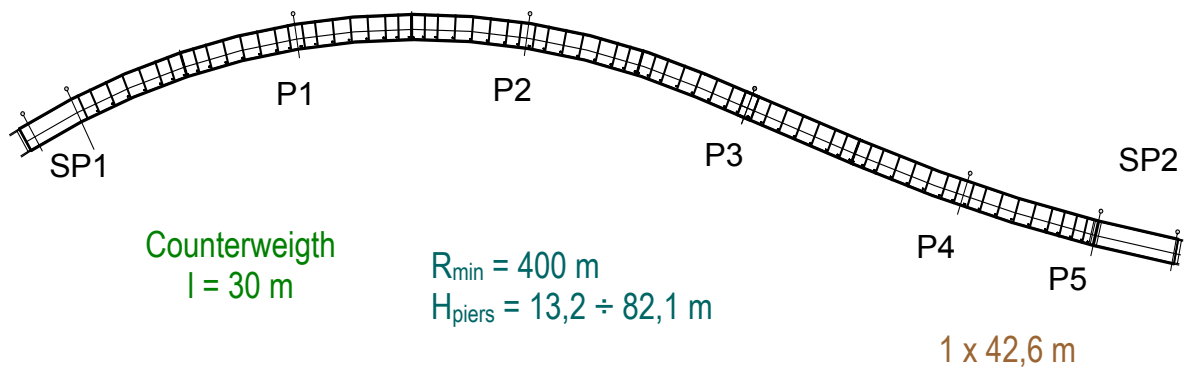

Figure 3 Viaduct planimetric shape

The conceptual design of the bridge considered the following possible solutions:

- Segmental construction with match cast joints and use of launching girder for the assembly, as it was practically impossible to supply segments of about 100t weight from the bottom of the valley.
- Classical cantilever with cast in situ segments and mixed prestressing: internal for construction phases, external for continuity tendons.
- Classical cantilever with composite deck and mixed prestressing: internal for construction phases, external for continuity tendons.

The first solution was abandoned due to the very high cost of the launching girder, which needed a vertical hinge because of the ratio between span and horizontal curvature radius.

The second solution was also discarded due to the long construction time that it would have required. In fact, only a couple of scaffolding resulted to be compatible with the total cost of the bridge.

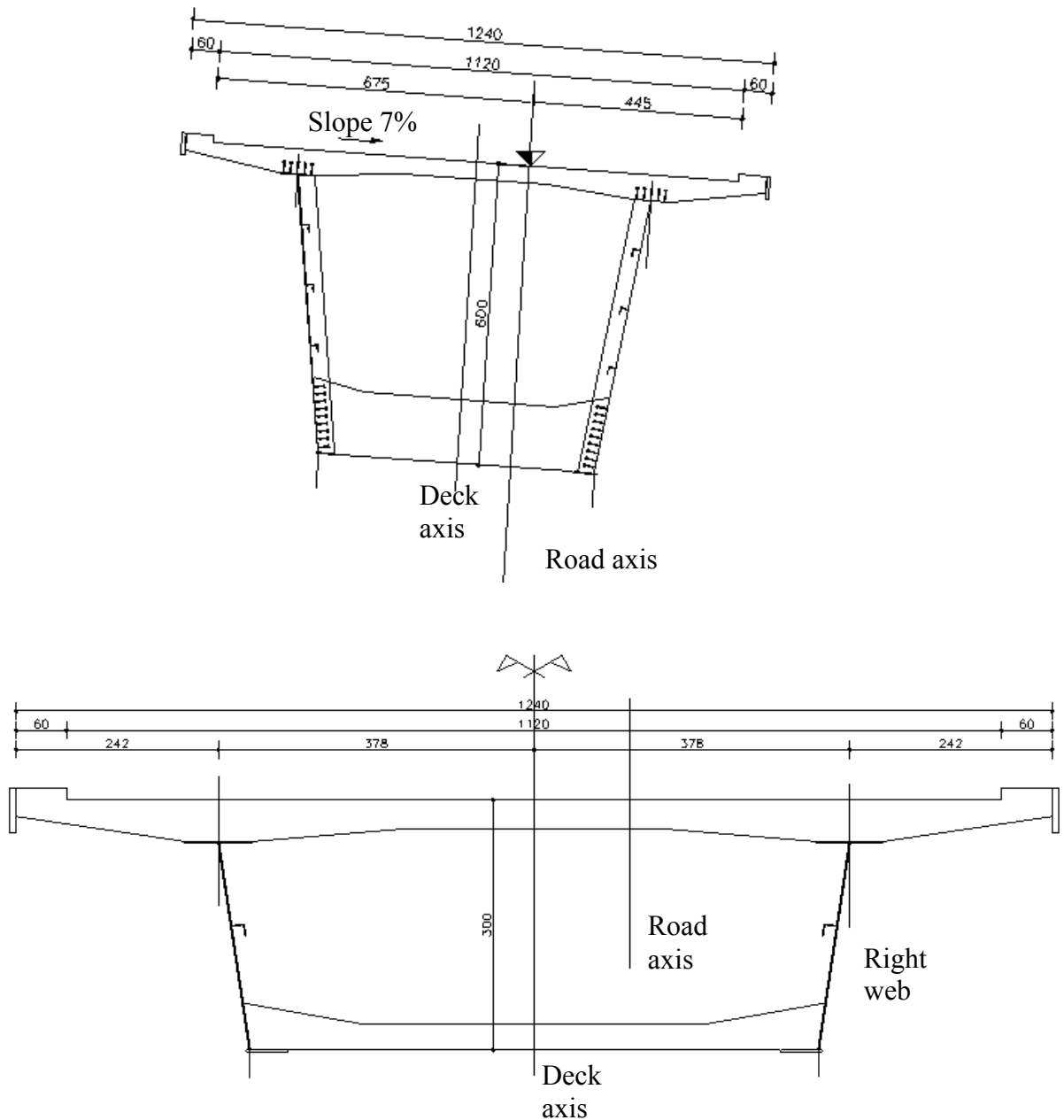

Figure 4 Transverse sections on the pier and at mid-span

The third solution was chosen both to reduce the execution time and to eliminate the cost of launching girder. In fact, as explained below, the assembling of the bridge required only a tower crane already used for the construction of the piers.

### Construction procedure

The construction sequence includes the following main steps:

- Positioning of the steel box of the pier segment, which is used as formwork for the following concreting of the diaphragm able both to transfer the torsion to the bearings and to anchor the cantilever to the pier by means of vertical prestressing

tendons. The latter aspect is very important during construction from the robustness point of view, as, if a segment fell down, the cantilever should keep its overall equilibrium as a rigid body on the pier. Figure 5 and 6 respectively show the pier segment ready for the assembling and its positioning on the top of the pier.



Figure 5 Pier segment ready to be assembled

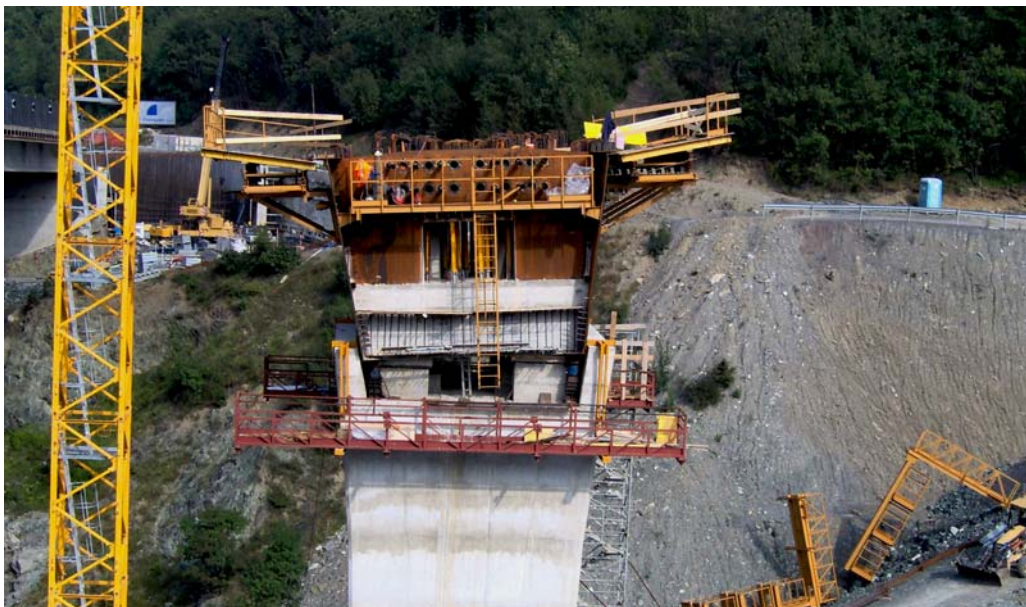

Figure 6 Pier segment assembled on the pier

- Assembling by bolts of the webs of the following segments on both sides and their adjustment and stiffening by means of temporary steel ties, which are removed after the casting of the top slab.



- Positioning of precast slabs of 60 mm thickness, stiffened by steel lattice, on the bottom flange of the steel webs. These slabs are used as formwork for the casting of the bottom concrete chord.
- Once the bottom chord is hardened, assembling of the scaffolding and formwork for casting the top slab, whose internal region lies on a scaffolding directly supported by the bottom slab, while the scaffolding of the external ones is tied to the webs by means of cross bolts. Figure 7 shows the bottom chord of the mid-span segment and the scaffolding and formwork of the top slab that is just cast.



Figure 7 Bottom and top chords with formwork and scaffolding

- Insertion of internal tendons, anchored on the pier segment of the hammers and their tensioning. In the case considered special precast blocks have been realised for the anchorage of prestressing tendons.



Figure 8 Precast anchorage blocks



They have been inserted in the formwork before the casting and designed using the indented construction joints model according to EN 1992-1-1 [3] and EN 1992-2 [4] (see figure 8).

- The procedure illustrated in the previous points is repeated for all the following segments, working in parallel on different piers in order to build several hammers at the same time (figure 9). At the end the completed cantilevers result to be built (figure 10).



Figure 9 Parallel construction of several hammers



Figure 10 Completed cantilever spanning 60m

When two adjacent cantilevers are completed, a complex step is their planimetric-altimetric adjustment. During construction all the structure is supported on the pier by means of a system of hydraulic jacks, so that, at the end, it is possible to recover the positioning errors by moving the hammer as a rigid body before the casting of actual bearing connections. Then the two cantilevers are mutually connected by ties, and the final steel joint and the last casting are realised (figure 11).



Figure 11 Final connection between adjacent cantilevers

We should also remember that, during construction, internal stiffeners (truss beams) and deviators are assembled inside the segments, as respectively shown in figure 12 and 13.



Figure 12 Internal stiffeners





Figure 13 External tendons deviators

It is now possible to place the external tendons, anchored on the opposite sides of pier segments, following the layout pictured in figures 14 and 15, and to apply the 50% of the final prestressing force, after the connection of each couple of hammers.

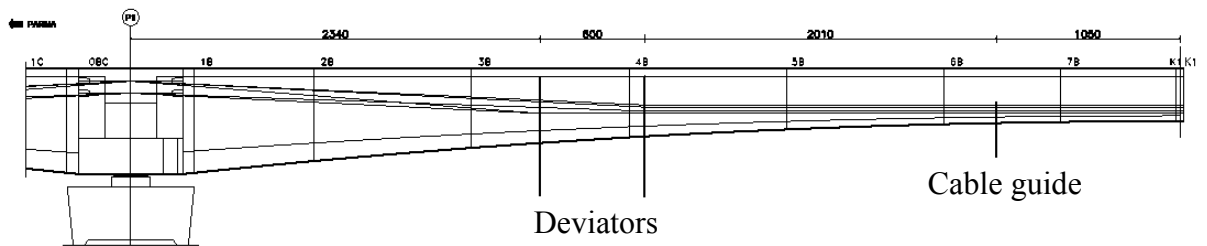

Figure 14 Layout of external tendons



Figure 15 Internal view of external tendons near the pier segment

The remaining 50% will be applied only on the final static scheme, as to say after the completion of the deck.

Finally, figures 16 and 17 show the completed bridge during two different steps of the final test performed using a number of loading trucks able to produce in the structure the stresses resulting from the characteristic combination of actions.



Figure 16 Completed bridge during the load test



Figure 17 View of the bridge during the load test

## Main aspects of design

One of the most difficult design aspect is the definition of cumbering during construction in so that the final configuration is reached in serviceability conditions. It has to be underlined that the cumbering system is a function of the constructing sequence, which cannot be modified once the final cumbering has been chosen and calculated.

A second important aspect is the correct evaluation of the following possible errors that, if present, should be compensated:

- Geometrical errors in cutting the steel webs. They are generally very small, due to the accurate production technologies and consequent reduced tolerances.
- Geometrical errors in the thickness of the concrete slabs. They can be controlled with accuracy during construction, thus producing limited consequences.
- Scattering of shrinkage and creep parameters. Due to great uncertainties of these phenomena, their effects should be preliminarily investigated with sensitivity analyses able to explore their most unfavourable combination.

Just to give an idea of the cumbering importance, figure 18 shows the construction geometry of the hammer of pier P1. As it can be appreciated, on the left side, towards the counterweight, the extremity of the cantilever is 30.86 cm higher than the pier segment, whereas the opposite extremity is only 9.25 cm higher. This dissymmetry takes into account the assembling sequence of the hammer and the important effect, in terms of displacement, induced by the external prestressing, which is applied to the two cantilevers in different static schemes.

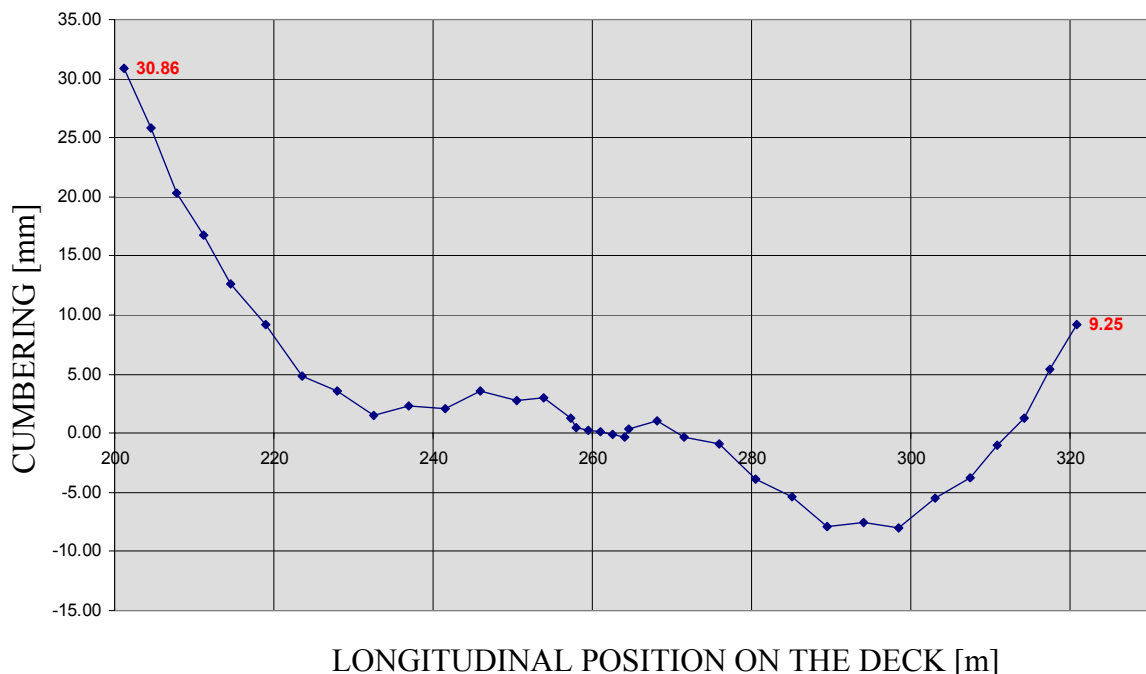

Figure 18 Cumbering of hammer on pier P1

In the case considered, the final result of such cumbering has been the necessity to correct the resulting profile with a medium increase of only 15mm paving thickness, which is fully acceptable considering the span and the planimetric geometry of the viaduct.

The redistribution of internal actions, both within the section and in the whole structure, due to the rheological behaviour of concrete, is another relevant aspect of design.

It is well known that, dealing with a composite structure, the principles of linear viscoelasticity cannot be used, and the general method for the evaluation of creep effects should be applied in agreement with EN1992-2. The fundamental equation used for the analysis of such effects is then:

$$\varepsilon_c(t) = \frac{\sigma_0}{E_c(t_0)} + \varphi(t, t_0) \frac{\sigma_0}{E_{c28}} + \sum_{i=1}^n \left( \frac{1}{E_{cti}} + \frac{\varphi(t, t_i)}{E_{c28}} \right) \Delta\sigma(t_i) + \varepsilon_{cs}(t, t_s) \quad (1)$$

in which the first term describes the instantaneous deformation due to stresses applied at time  $t_0$ , whereas the second term represents the viscous deformation due to the same state of stress, the third term the amount of instantaneous and viscous deformation that takes place at time  $t_i$ , and the fourth term the shrinkage deformation. Expression (1) should be used in a time history, that follows the assembling operations, for instance the casting of a couple of segments.

On the other hand, the losses of the external tendons are evaluated using the mean stress between two adjacent deviators, because in serviceability conditions no slip is expected to rise in those devices.

As can be easily expected in such kind of structures, a strong redistribution of internal actions in time, in particular for what concerns the effects of prestressing, takes place from concrete to steel. An accurate analysis of the stability of steel plates and a careful design of bolted connections are therefore required.

Figure 19 illustrates the evolution, during construction, of stresses on the top and the bottom flange of the steel web of the first segment after the pier-diaphragm. We can appreciate that, as it could have been easily guessed, the bottom flange is compressed in every step, but also that the top flange becomes compressed after the introduction of prestressing in the second segment.

Figure 20 shows the same stresses in mid-span: both the flanges are compressed at infinite time, but the upper one is tensed as far as the external prestressing is completed. After this operation, which is identified by phase 33, a significant migration of stresses from concrete to steel can be easily appreciated, too.

This phenomenon reduces the residual compressive stresses in concrete but, in any case, it is not able to give rise to tensile stresses under serviceability conditions (frequent combination of actions).

This migration could be substantially reduced if corrugated steel webs were used, choice that nevertheless implies an increase of about 30% in steel weight.

Even if elegant and external prestressing saving, this solution is today inconvenient from an economical point of view, in particular taking into account the recent publication of EN1993-1-5 [5]. In fact, this code, unlike the previous ones generally



used in the design, allows for a strong reduction in stiffeners to be used in plated structural elements.

### BOTTOM FLANGE STRESS

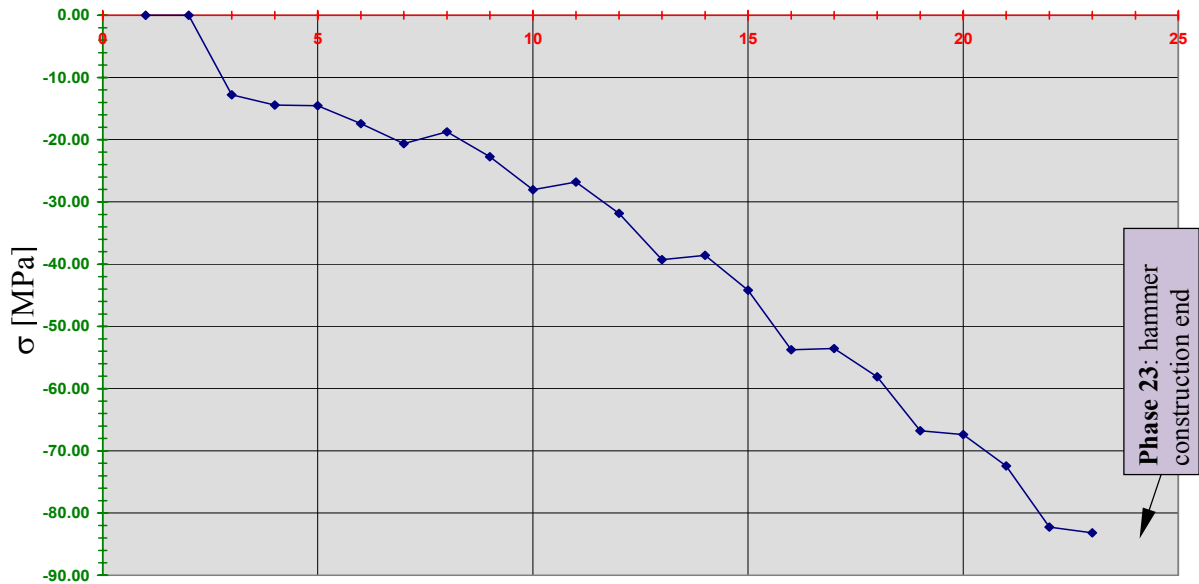

### TOP FLANGE STRESS

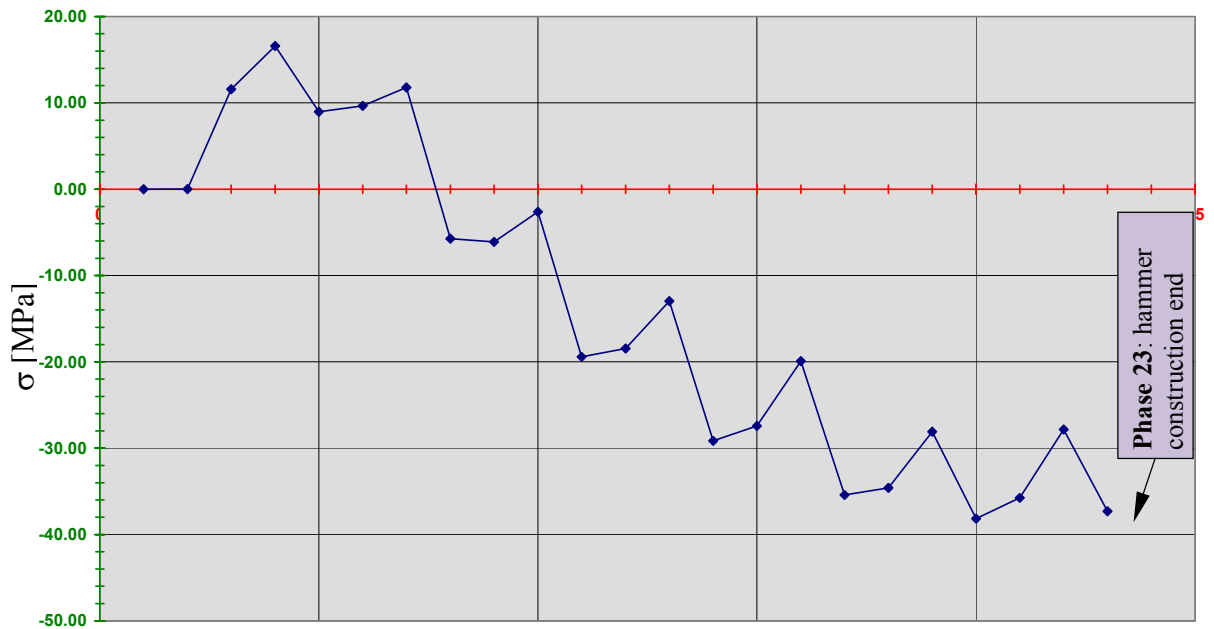

Figure 19 Stresses evolution in top and bottom steel flanges in the first segment during the construction process

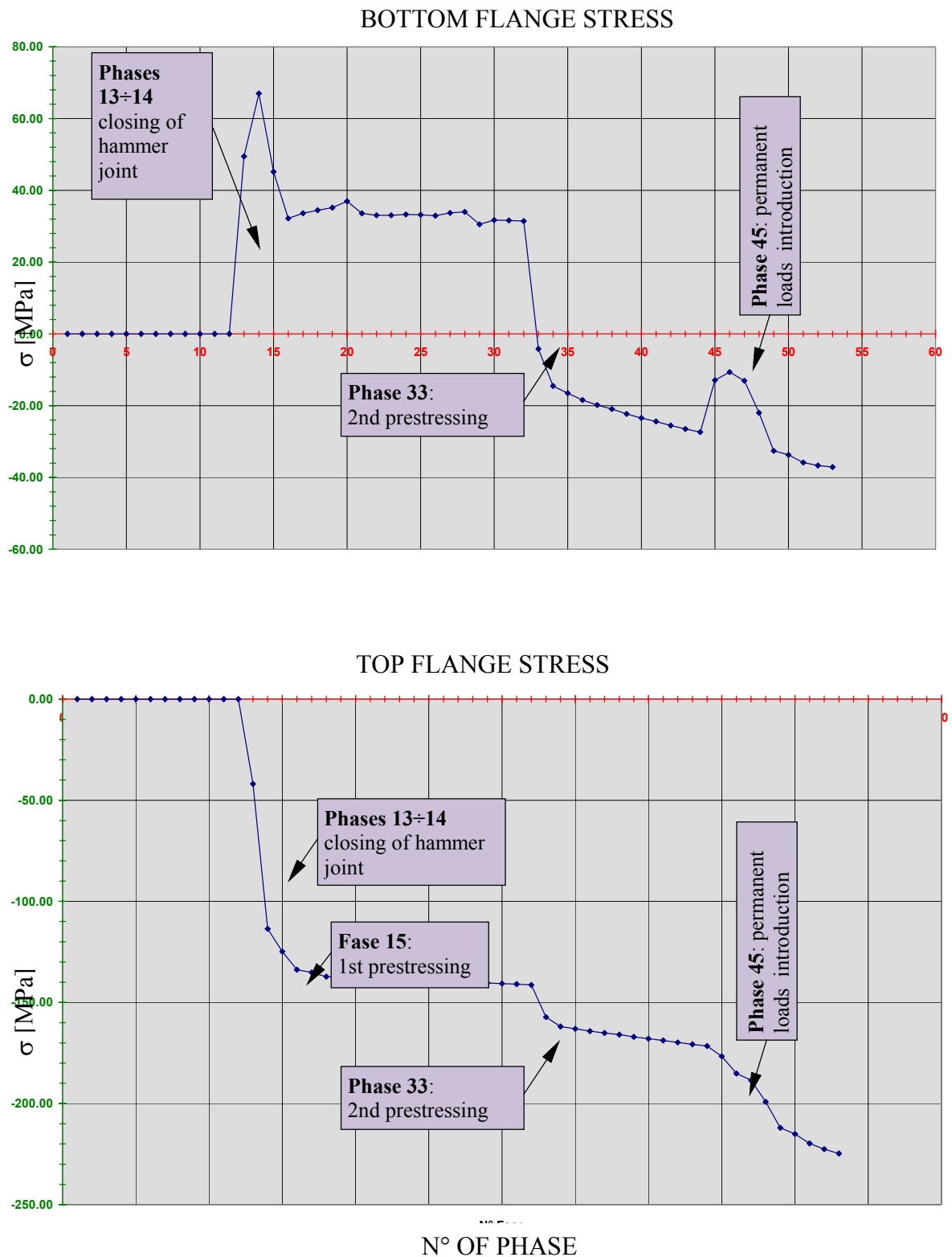

Figure 20 Stresses evolution in top and bottom steel flanges in the mid-span segment during the construction process

## CONCLUSIONS

It clearly results, from the above discussion, that the solution of composite steel-concrete deck with additional external prestressing results to be sustainable from several points of view:

- Durability: due to the absence of longitudinal tensile stresses in concrete in serviceability conditions, in particular in frequent combination of actions.
- Economy: both for the reduction of construction time and for the elimination of a very expensive launching girder.
- Environmental impact reduction: because the large areas that are usually necessary for the construction and storage of concrete precast segments are eliminated.
- Maintenance: as it is possible to inspect and control very easily the external tendons.
- Rehabilitation: because it is possible to substitute the external tendons without significant limitation to the traffic.

Another noticeable remark is that this kind of deck, on a static scheme of continuous beam, is economical up to spans of 160-170m, enlarging thus the field of possible solutions using continuous concrete box girder bridges. For larger spans, up to 250 m, the proposed solution may result acceptable with the adoption of the static scheme of extradosed bridge, as clearly demonstrated by several structures built in Japan.

Lastly, in the case of the bridge under consideration, the following quantities of material employment (per square meter of deck) can be reminded:

- Concrete:  $0.85 \text{ m}^3/\text{m}^2$
- Steel:  $220 \text{ kg}/\text{m}^2$
- Prestressing steel (internal and external):  $60 \text{ kg}/\text{m}^2$
- Ordinary reinforcement  $170 \text{ kg}/\text{m}^2$

Such data clearly put in evidence the economy of the chosen solution.

## REFERENCES

1. BURDTLAND, G H. Common future. The World Commission Environment and Development (WCED), Oxford U.P., 1987.
2. *fib* Bulletin 28. Environmental Design – State of Art Report. Lausanne, February 2004.
3. EN 1992-1-1. Design of Concrete structures – Part 1.1: General rules and rules for buildings. CEN, December 2004.
4. EN 1992-2. Design of Concrete structures – Part 2: Concrete bridges, Design and detailing rules. CEN, June 2005.
5. EN 1993-1-5. Design of steel structures – Part 1.5: Plated structural elements. CEN, September 2005.

